

SPACE BATTLELAB ACTIVITY BOOK





LOST IN SPACE

S Y E
L E A D S L S
S Z S Q G L I P T T N
Y O P H A G K I O A T X O
Q H A L L D T D M E R C U R Y
O K N A L A S E R S N E E H B
X F C X S H O T R L R D N T F S D
C B I K M N E P E E L U M N S T B
S L E B Q A O M M A R T I A N S A L E
S S A T U R N K T V P S I T A L R T T
K K F Z S S T E L E S C O P E V S G F
P U U X I K Y N I P J P L U T O D
R I F B C I P L A N E T S W J V N
X R O O P E G S F T U L S P Z
O R E X A R K T A N G M Y V I
L X J N R P B E B U V L S
G B C G J V G T I Q W
F W Q X R H N
R X E

ALIEN
BATTLELAB
JUPITER
MARTIANS
MISSILE
ORBIT
PLUTO
SATURN
STARS
TELESCOPE

APOLLO
ET
LASERS
MERCURY
NEPTUNE
PLANETS
ROCKET
SHUTTLE
SUN
UFO

ASTEROIDS
GALAXIES
MARS
METEORS
NOVA
PLASMA
SATELLITE
SPACE
TANG
VENUS





SPACE CROSSINGS

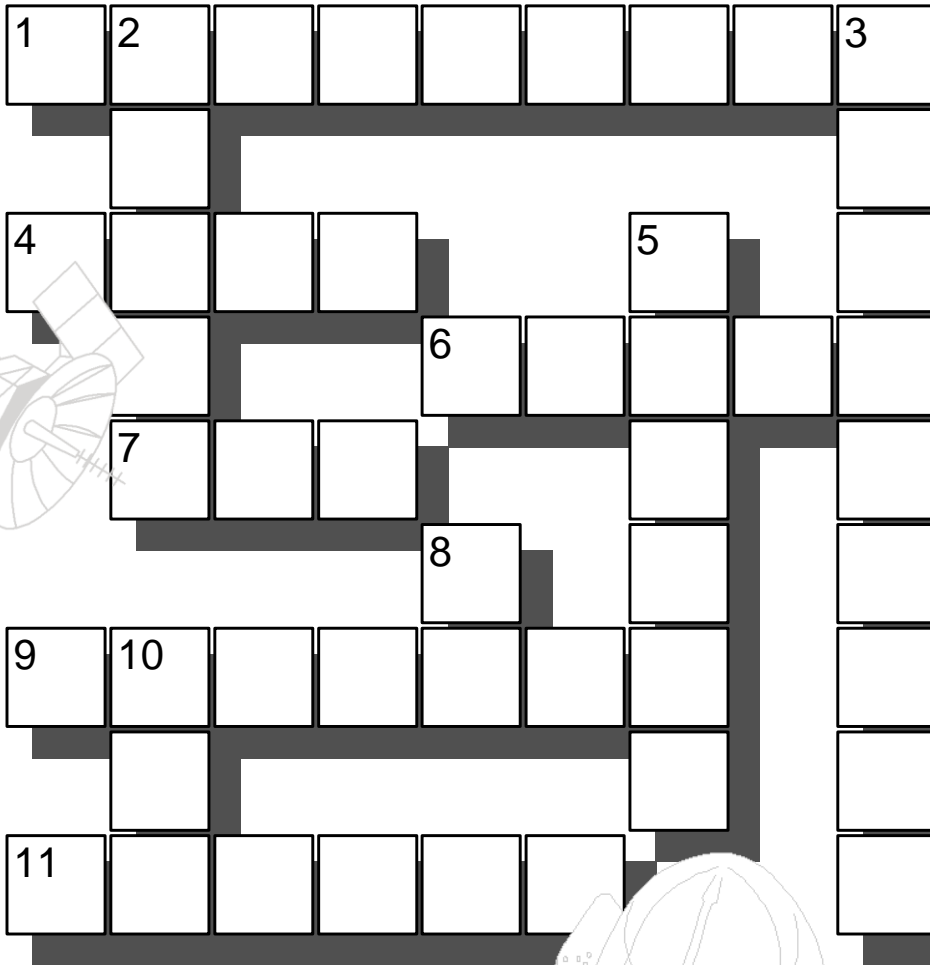

[Across]

1. These are big chunks of rock floating in space; also a video game
4. A big red planet
6. The final frontier; It surrounds all of the planets.
7. If you look directly at this it will blind you
9. This planet has a big red eye
11. We use these to launch satellites into space

[Down]

2. You see these in the sky at night
3. These orbit the earth all of the time
5. This planet has rings around it
8. All he wanted to do is "phone home"
10. Martians come to earth in these

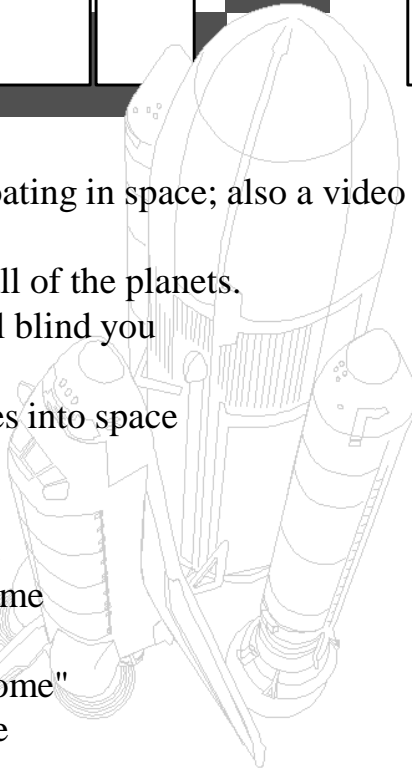
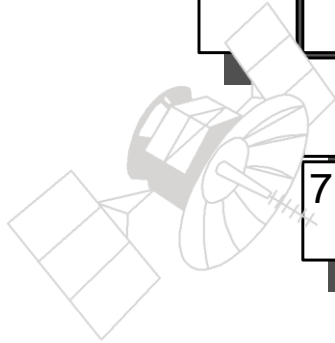



COLOR ME IN

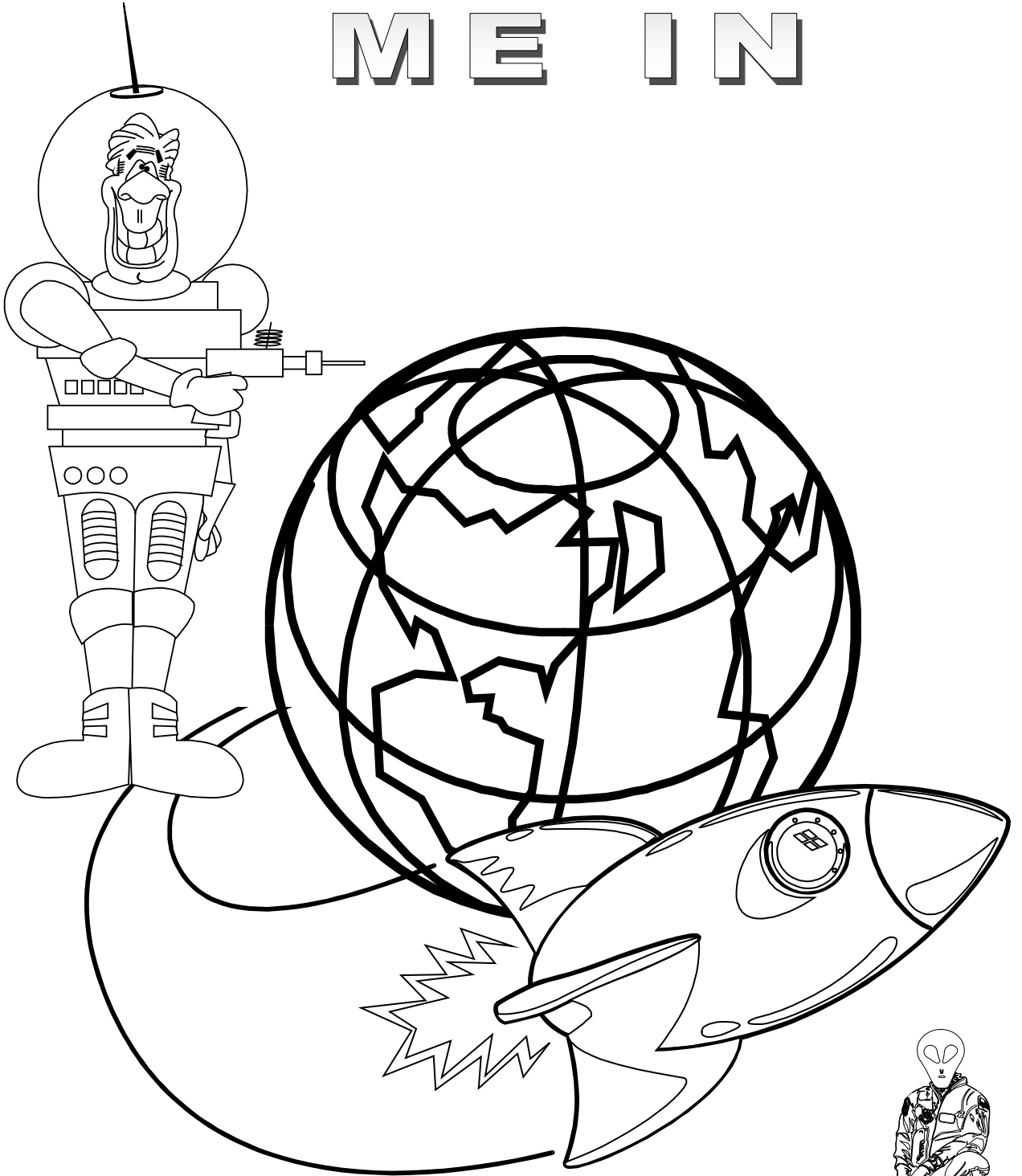



CONNECT- THE- DOTS

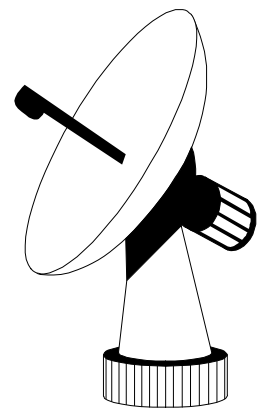
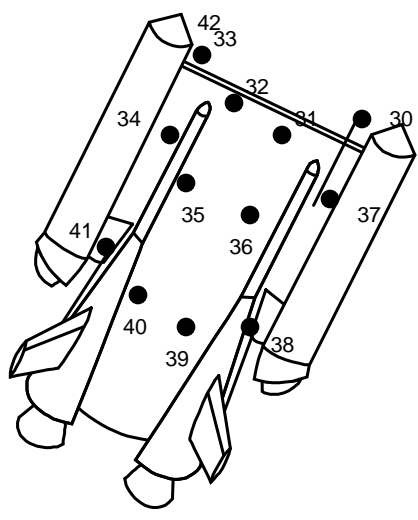
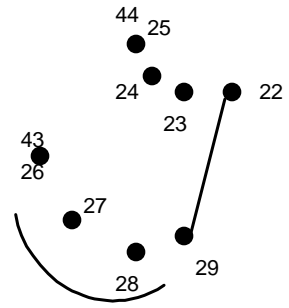
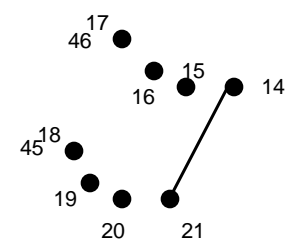
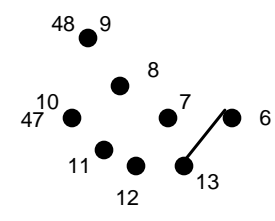
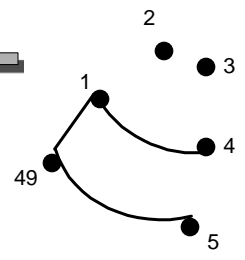
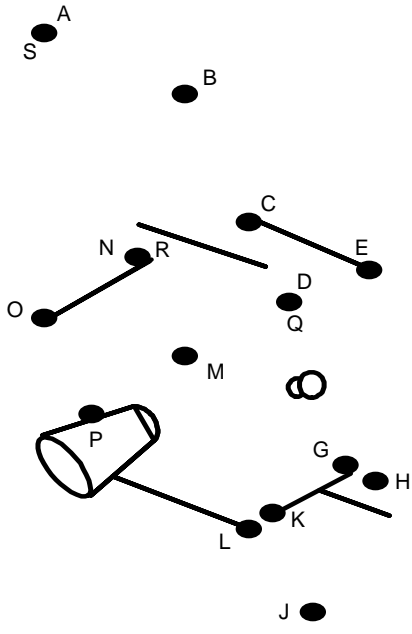



COLOR ME IN

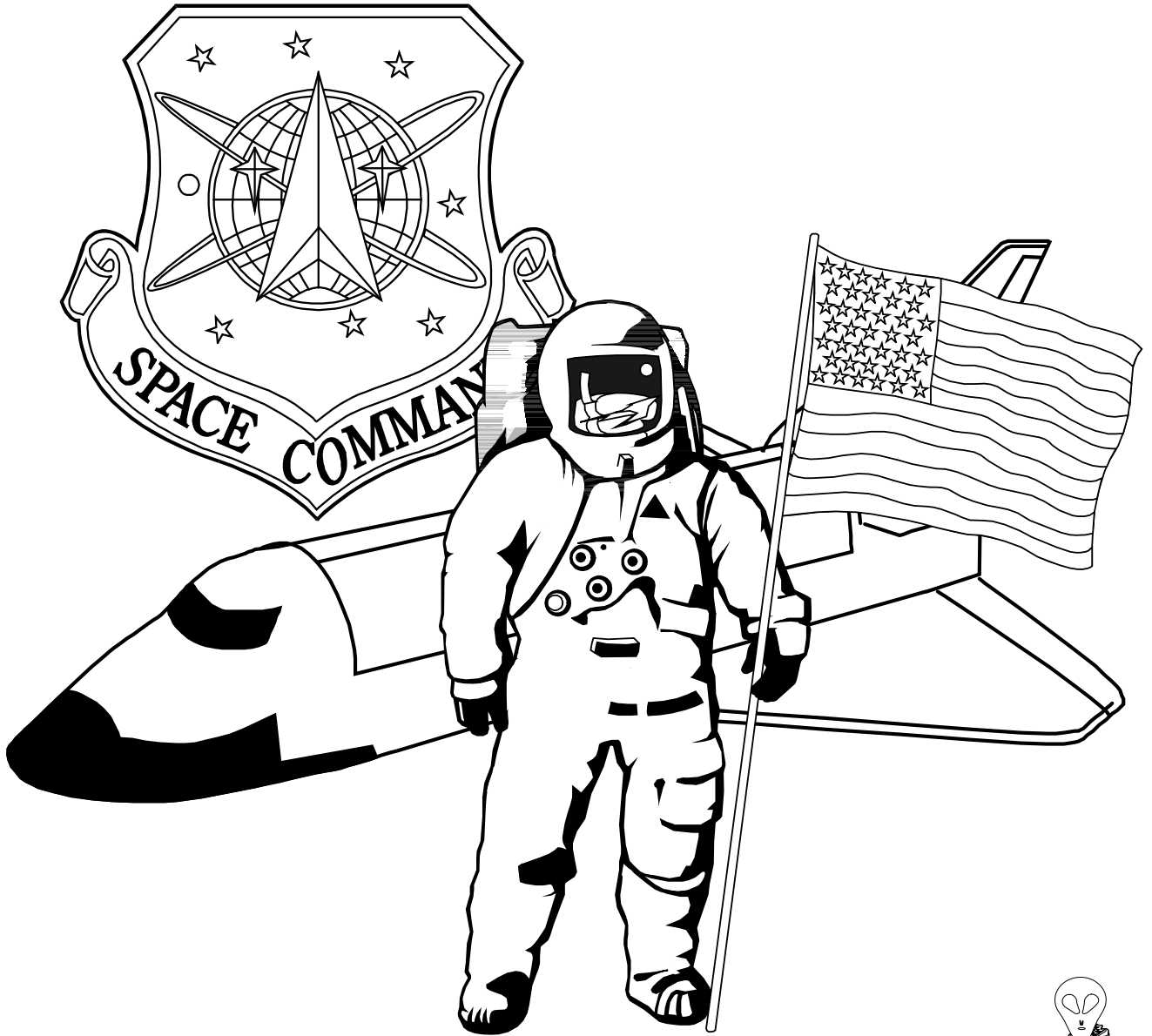



LOST IN SPACE

Help the
Lunar
Lander find
its way
home to
Earth.

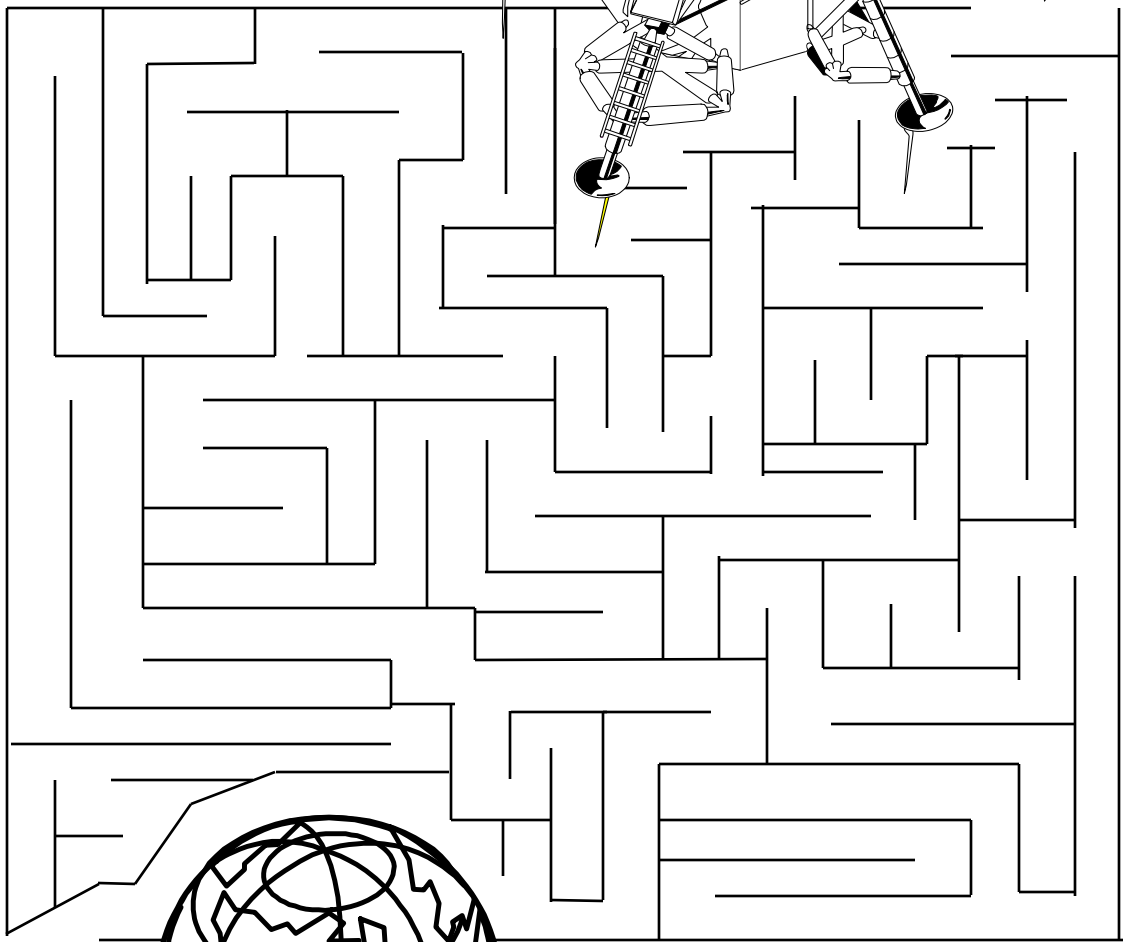
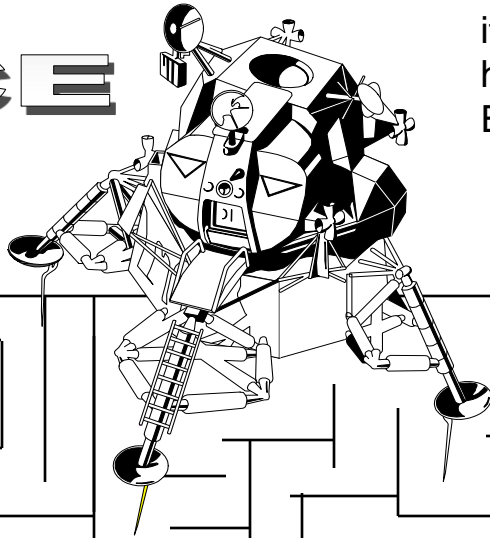



DRAW YOUR OWN SPACE PICTURE





ANSWERS

